

# Solid State Relays

## 4-Pin SIP Package—VDC Input / VAC Output

### OSSRD1001A thru OSSRD1006A



---

#### Features:

- Molded Epoxy package
- Zero crossing circuit
- High Input/output Optical Isolation 4k Vrms
- Small size and light weight
- Can be installed directly on the P.C. board
- Fast switching time
- Non-contact switch

#### Approval Agency:

- UL and VDE Pending

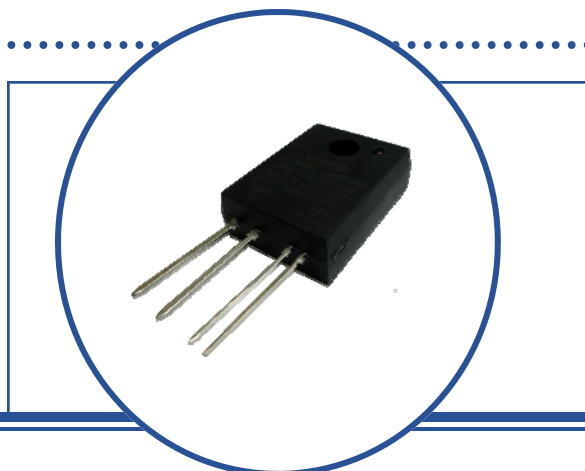

#### Description:

The OSSR Solid State Relay series are electronic controlled switches, they contain no moving parts. When voltage is applied to the input, a Light Emitting Diode or LED illuminates a Photosensor which controls the internal output circuit. The output circuit is utilized to drive high current loads. The input and output are optically isolated. The OSSR series incorporates a zero crossing circuit which minimizes current and noise surges due to resistive and inductive loads. Optek provides three different electrical configurations of the OSSR series: DC input – AC output, AC input – AC output and DC input – DC output. These configurations meet most industry applications.

The **OSSRD100XA** family comes in a standard 4-pin SIP, Single In-Line Package, for PCB mounting applications. The package offers a light weight, compact and robust molded epoxy body with extended operating temperature range of up to 100°C.

The input circuit features a DC range from 5 to 12 VDC. The output consists of a Triac circuit featuring load current ratings from 3 to 40 Amps and a maximum load voltage of 250VAC with normally open output.

---

#### Applications:

- Temperature controlled systems
- Office equipment
- Motor controls
- Industrial Equipment
- Light controls systems
- Heater control
- Appliances
- HVAC temperature control
- Plastic molding
- Packaging industry



OPTEK reserves the right to make changes at any time in order to improve design and to supply the best product possible.

# Solid State Relays

## 4-Pin SIP Package—VDC Input / VAC Output

### OSSRD1001A thru OSSRD1006A



Package Outline: 4-Pin SIP

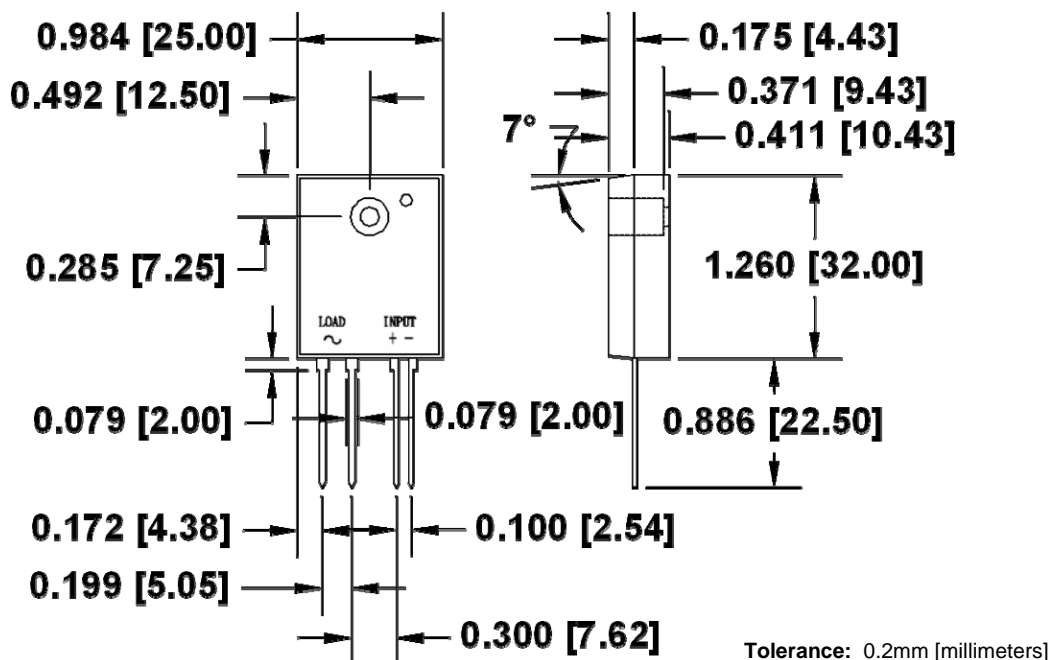

Schematic: Top View

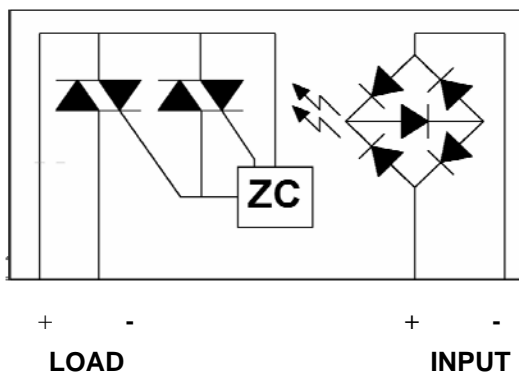

OSSRD1001A— OSSRD1006A

### Pin Configuration

Part Number	Pin #			
	1	2	3	4
OSSRD1001A	A	K	A1 (+)	A2 (-)
OSSRD1002A	A	K	A1 (+)	A2 (-)
OSSRD1003A	A	K	A1 (+)	A2 (-)
OSSRD1004A	A	K	A1 (+)	A2 (-)
OSSRD1005A	A	K	A1 (+)	A2 (-)
OSSRD1006A	A	K	A1 (+)	A2 (-)

OPTEK reserves the right to make changes at any time in order to improve design and to supply the best product possible.

# Solid State Relays

## 4-Pin SIP Package—VDC Input / VAC Output

### OSSRD1001A thru OSSRD1006A



### VDC Input / VAC Output Devices Ordering Information

Part Number	Input	Min. Tgr Current lft	Max. Output Current	Min. Ouput Current	Max. Vout	Min. Vout	Output Type	Br. Vol. Input to Output	Configuration
OSSRD1001A	5-12VDC	50mA	3A	0.05A	250VAC	50VAC	AC	4000VAC	BR —A1(+) A2(-)
OSSRD1002A	5-12VDC	50mA	5A	0.05A	250VAC	50VAC	AC	4000VAC	BR—A1(+) A2(-)
OSSRD1003A	5-12VDC	50mA	10A	0.05A	250VAC	50VAC	AC	4000VAC	BR —A1(+) A2(-)
OSSRD1004A	5-12VDC	50mA	15A	0.05A	250VAC	50VAC	AC	4000VAC	BR —A1(+) A2(-)
OSSRD1005A	5-12VDC	50mA	25A	0.05A	250VAC	50VAC	AC	4000VAC	BR —A1(+) A2(-)
OSSRD1006A	5-12VDC	50mA	40A	0.05A	250VAC	50VAC	AC	4000VAC	BR —A1(+) A2(-)
Configuration: Definition of Terms LED Identification—Sensor Identification									
Configuration Information	LED		BR - Bridge Rectifier						
	Sensor		A1(+) and A2(-) = Main Terminals of Double Triac						

### Part Number Symbolization

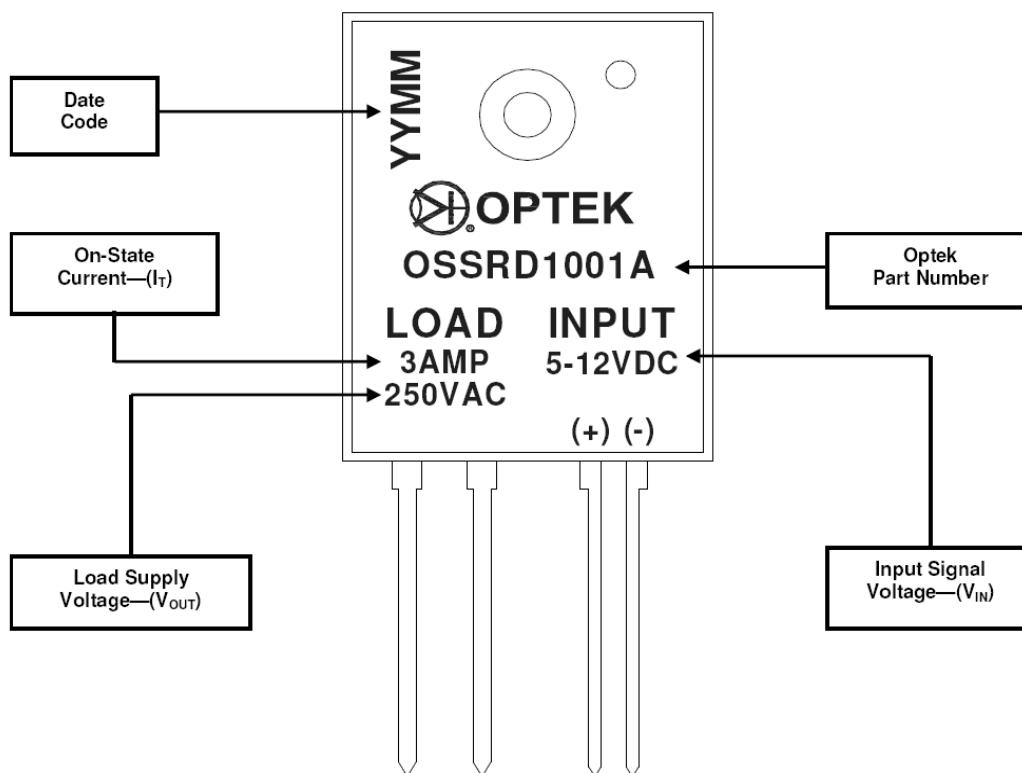

OPTEK reserves the right to make changes at any time in order to improve design and to supply the best product possible.

# Solid State Relays

## 4-Pin SIP Package—VDC Input / VAC Output

### OSSRD1001A thru OSSRD1006A



#### Absolute Maximum Ratings ( $T_A = 25^\circ\text{C}$ unless otherwise noted)

<b>Storage Temperature</b> OSSRD1001A thru OSSRD1006A	-30° C to +125° C
<b>Operating Temperature</b> OSSRD1001A thru OSSRD1006A	-30° C to +100° C
<b>Isolation Voltage (Input to Output)</b> OSSRD1001A thru OSSRD1006A	4,000 Vrms
<b>Soldering Temperature 10 sec.</b> OSSRD1001A thru OSSRD1006A	260° C

#### Input Diode

<b>Input Signal Voltage—(<math>V_{IN}</math>)</b> OSSRD1001A thru OSSRD1006A	5– 12 VDC
<b>Drop-out Voltage—(<math>V_{do}</math>)</b> OSSRD1001A thru OSSRD1006A	1 VDC

#### Output Triac

<b>RMS On-State Current - (<math>I_T</math>)</b> OSSRA1001A OSSRA1002A OSSRA1003A OSSRA1004A OSSRA1005A OSSRA1006A	3 Arms 5 Arms 10 Arms 15 Arms 25 Arms 40 Arms
<b>Peak One Cycle Surge Current - (<math>I_{surge}</math>)</b> OSSRA1001A OSSRA1002A OSSRA1003A OSSRA1004A OSSRA1005A OSSRA1006A	30 A 50 A 100 A 150 A 250 A 400 A
<b>Repetitive Peak-Off State Voltage—(<math>V_{DRM}</math>)</b> OSSRD1001A thru OSSRD1006A	600 V
<b>Operating Frequency—(<math>f</math>)</b> OSSRD1001A thru OSSRD1006A	47—70 Hz
<b>Critical Rate of Rise of On-State Current—(<math>di/dt</math>)</b> OSSRD1001A thru OSSRD1006A	50 A/ $\mu$ S
<b>Load Supply Voltage—(<math>V_{OUT}</math>)</b> OSSRD1001A thru OSSRD1006A	250 Vrms AC

OPTEK reserves the right to make changes at any time in order to improve design and to supply the best product possible.

# Solid State Relays

## 4-Pin SIP Package—VDC Input / VAC Output

### OSSRD1001A thru OSSRD1006A



#### Electrical Characteristics

SYMBOL	PARAMETER	MIN	TYP	MAX	UNITS	TEST CONDITIONS
--------	-----------	-----	-----	-----	-------	-----------------

#### Input Diode

$V_{PU}$	<b>Pick-up Voltage</b> OSSRD1001A thru OSSRD1006A	-	-	4	VDC	$I_T = 1A_{rms}$
$I_{IN}$	<b>Input Current</b> OSSRD1001A thru OSSRD1006A	5	-	35	mA	$V_{IN} = 5 - 12 V$

#### Output Triac

$V_T$	<b>On-State Voltage</b> OSSRD1001A thru OSSRD1006A	-	-	1.5	Vrms	$I_T = 1A_{rms}$
$I_{OP}$	<b>Operating Current</b> OSSRD1001A thru OSSRD1006A	50	-	-	mArms	$V_{out} = 240V_{rms}$
$I_{LEAK}$	<b>Leakage Current</b> OSSRD1001A thru OSSRD1006A	-	-	7	mArms	$V_{out} = 240V_{rms}$
dv/dt	<b>Critical Rate of Rise of Off-State Voltage</b> OSSRD1001A thru OSSRD1006A	50	200	-	V/ $\mu$ s	See Note 1.
-	<b>Zero-Cross Voltage</b> OSSRD1001A thru OSSRD1006A	-	Yes	-	-	-
$V_{OUT}$	<b>Load Voltage Rating</b> OSSRD1001A thru OSSRD1006A	50	-	280	VAC	$I_T = 50mArms$ MIN
$I_{FT}$	<b>Minimum Trigger Current</b> OSSRD1001A, OSSRD1002A, OSSRD1003A OSSRD1004A, OSSRD1005A, OSSRD1006A	-	-	10 25	mA	$V_{DRM} = 600 V$ $V_{DRM} = 600 V$
Riso	<b>Isolation resistance Input to Output</b> OSSRD1001A thru OSSRD1006A	$10^{10}$	-	-	$\Omega$	DC500 V
$T_{ON}$	<b>Turn-on Time</b> OSSRD1001A thru OSSRD1006A	-	-	8.3	mS	60Hz AC
$T_{OFF}$	<b>Turn-off Time</b> OSSRD1001A thru OSSRD1006A	-	-	8.3	mS	60Hz AC
Rth (j-C)	<b>Thermal Resistance (between junction and case)</b>	-	1.3	-	$^{\circ}C/W$	-

**Note1:** Output (dv/dt) protection is provided in all models, and they are designed to switch resistive or inductive loads to 0.2 factor. The dv/dt rating is based on source impedance of 50 ohms.

OPTEK reserves the right to make changes at any time in order to improve design and to supply the best product possible.

# Solid State Relays

## 4-Pin SIP Package—VDC Input / VAC Output

### OSSRD1001A thru OSSRD1006A

## OSSRD1001A

### Characteristic Data Curves

**Fig.1** RMS On-state Current vs. Ambient Temperature

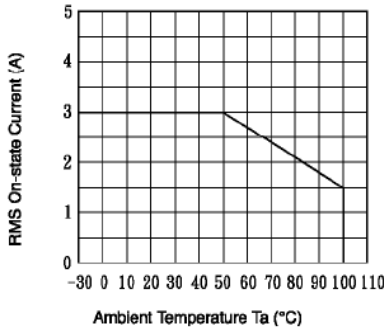

**Fig.2** Surge Current vs. Time

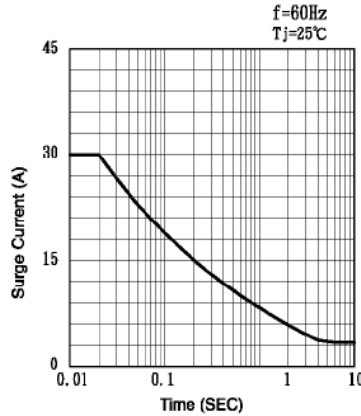

**Fig.3** Open Circuit Leak Current vs. Supply Voltage

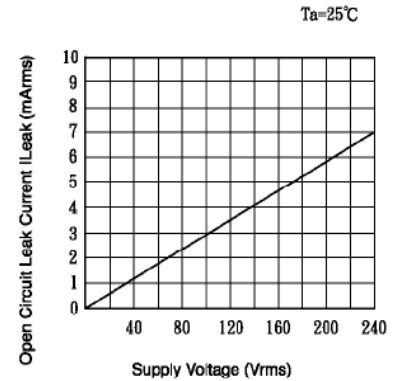

**Fig.4** RMS On-state Current vs. Case Temperature

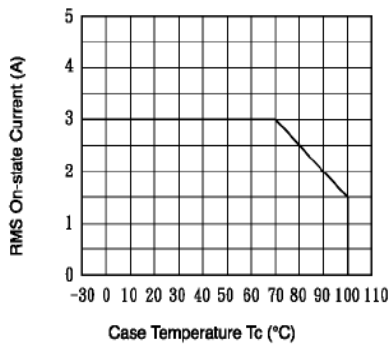

**Fig.5** Input Voltage vs. Ambient Temperature

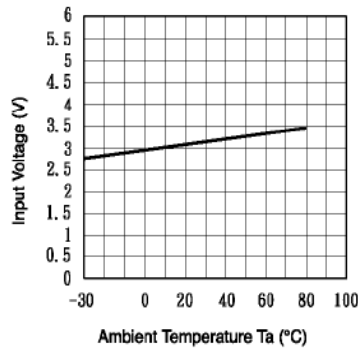

**Fig.6** Input Current vs. Input voltage

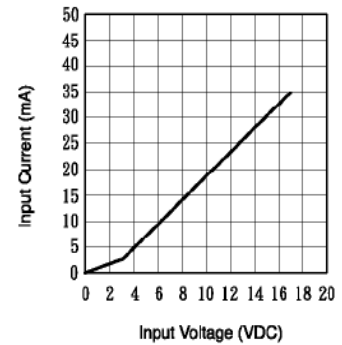

**Fig.7** Action waveform

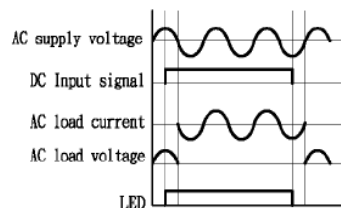

**Fig.8** WIRING DIAGRAM

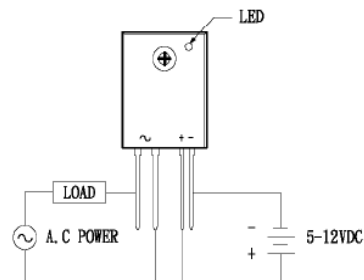

OPTEK reserves the right to make changes at any time in order to improve design and to supply the best product possible.

# Solid State Relays

## 4-Pin SIP Package—VDC Input / VAC Output

### OSSRD1001A thru OSSRD1006A

## OSSRD1002A

### Characteristic Data Curves

**Fig.1 RMS On-state Current vs. Ambient Temperature**

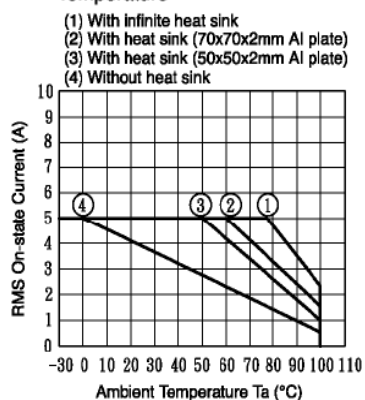

**Fig.2 Surge Current vs. Time**

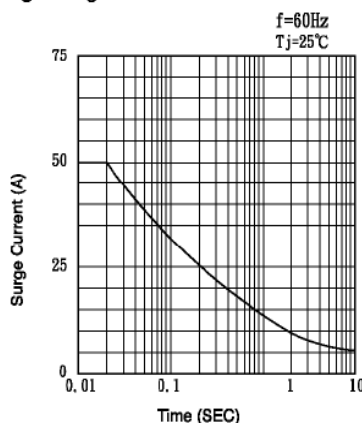

**Fig.3 Open Circuit Leak Current vs. Supply Voltage**

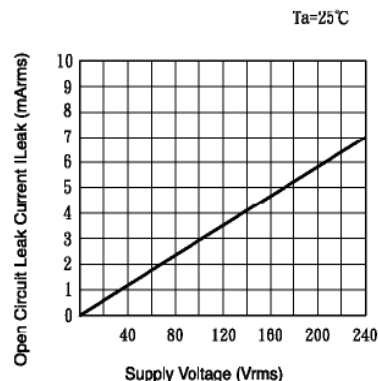

**Fig.4 RMS On-state Current vs. Case Temperature**

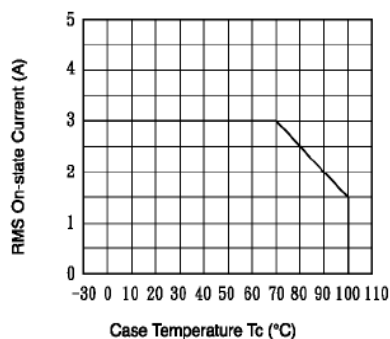

**Fig.5 Input Voltage vs. Ambient Temperature**

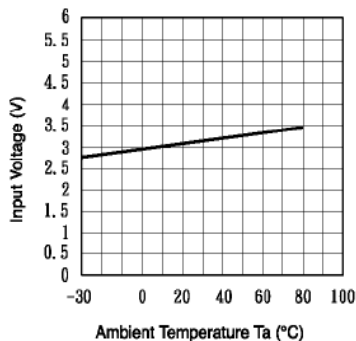

**Fig.6 Input Current vs. Input voltage**

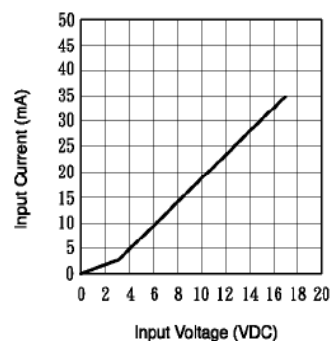

**Fig.7 Action waveform**

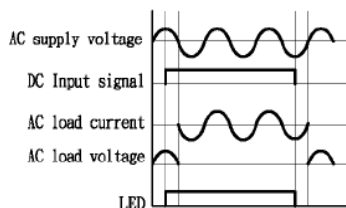

**Fig.8 WIRING DIAGRAM**

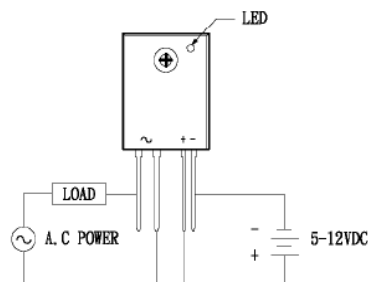

OPTeK reserves the right to make changes at any time in order to improve design and to supply the best product possible.

# Solid State Relays

## 4-Pin SIP Package—VDC Input / VAC Output

### OSSRD1001A thru OSSRD1006A



### OSSRD1003A

#### Characteristic Data Curves

**Fig.1** RMS On-state Current vs. Ambient Temperature

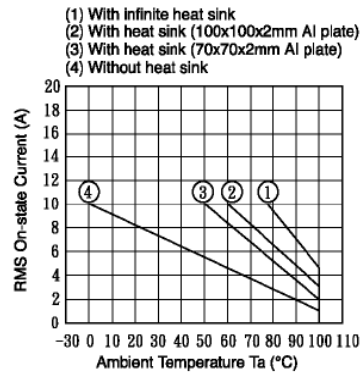

**Fig.2** Surge Current vs. Time

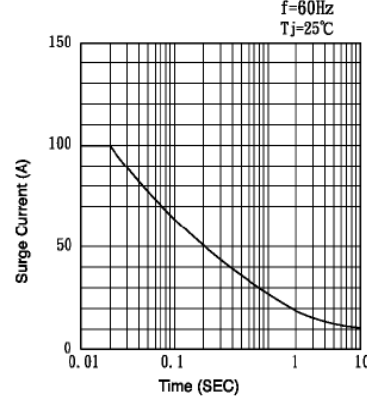

**Fig.3** Open Circuit Leak Current vs. Supply Voltage

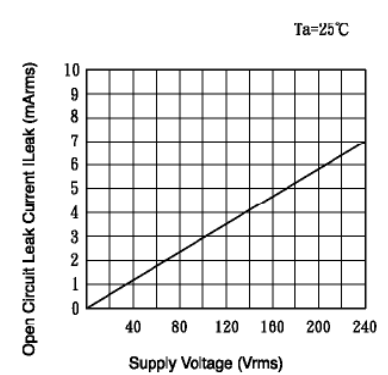

**Fig.4** RMS On-state Current vs. Case Temperature

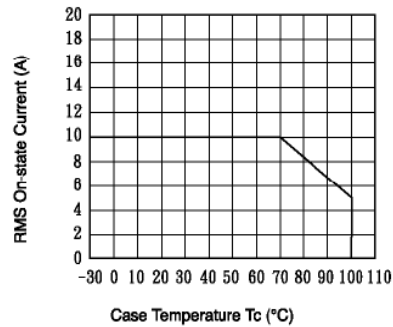

**Fig.5** Input Voltage vs. Ambient Temperature

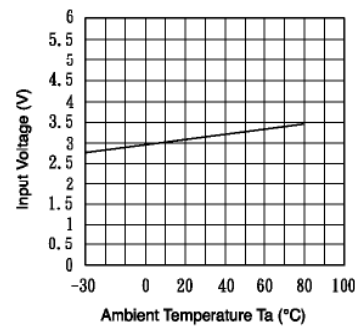

**Fig.6** Input Current vs. Input voltage

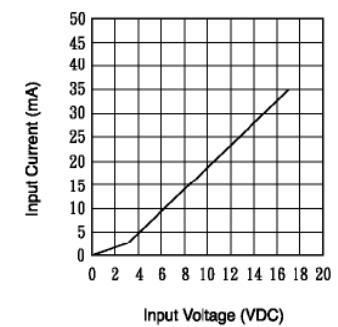

**Fig.7** Action waveform

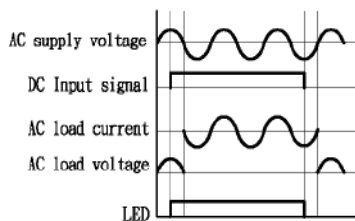

**Fig.8** WIRING DIAGRAM

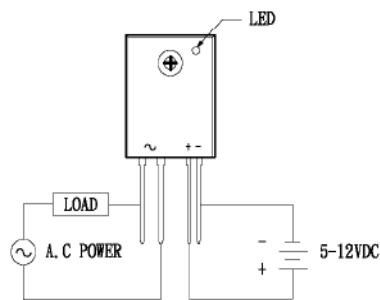

OPTEK reserves the right to make changes at any time in order to improve design and to supply the best product possible.



# Solid State Relays

## 4-Pin SIP Package—VDC Input / VAC Output

### OSSRD1001A thru OSSRD1006A



### OSSRD1004A

#### Characteristic Data Curves

**Fig.1** RMS On-state Current vs. Ambient Temperature

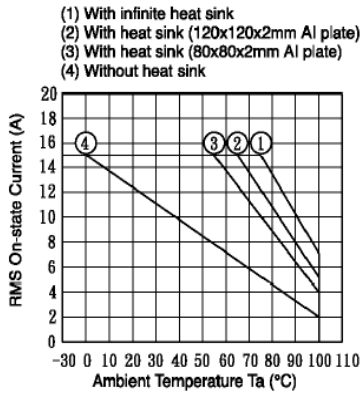

**Fig.2** Surge Current vs. Time

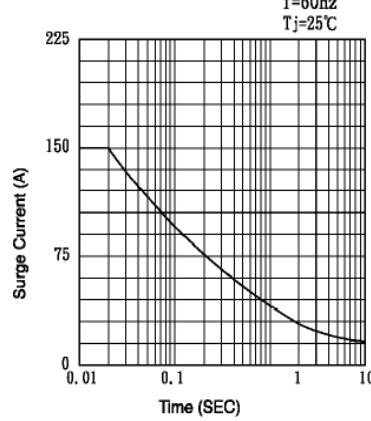

**Fig.3** Open Circuit Leak Current vs. Supply Voltage

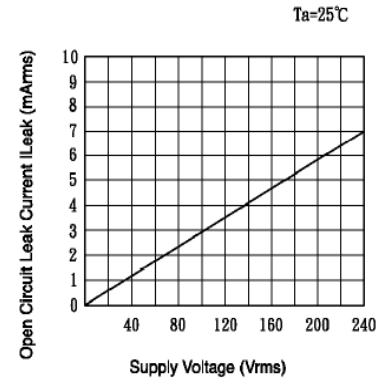

**Fig.4** RMS On-state Current vs. Case Temperature

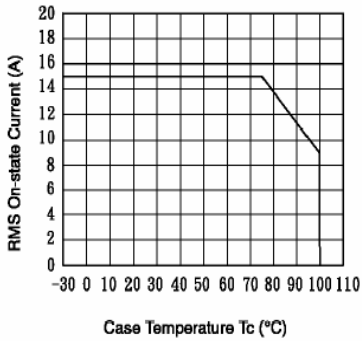

**Fig.5** Input Voltage vs. Ambient Temperature

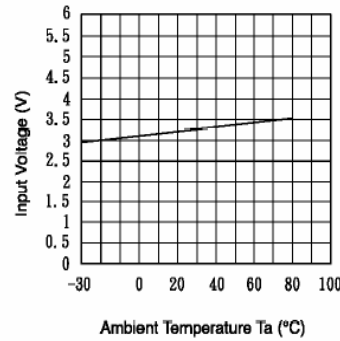

**Fig.6** Input Current vs. Input voltage

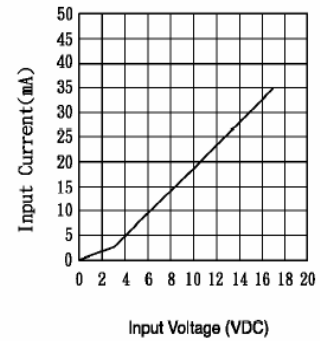

**Fig.7** Action waveform

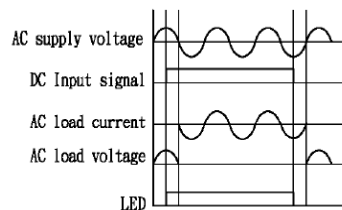

**Fig.8** WIRING DIAGRAM

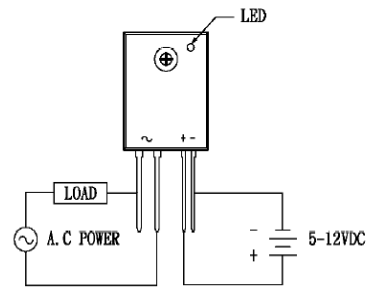

OPTeK reserves the right to make changes at any time in order to improve design and to supply the best product possible.

# Solid State Relays

## 4-Pin SIP Package—VDC Input / VAC Output

### OSSRD1001A thru OSSRD1006A



### OSSRD1005A

#### Characteristic Data Curves

**Fig.1 RMS On-state Current vs. Ambient Temperature**

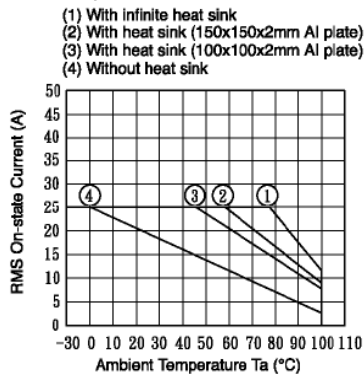

**Fig.2 Surge Current vs. Time**

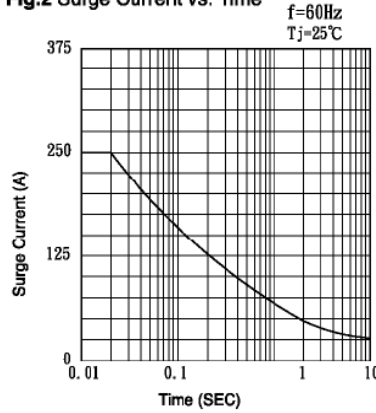

**Fig.3 Open Circuit Leak Current vs. Supply Voltage**

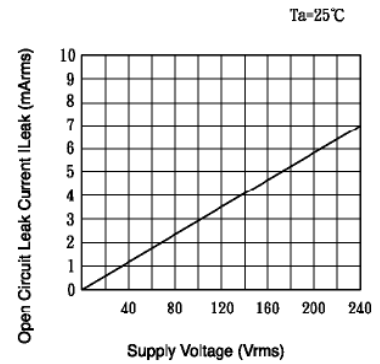

**Fig.4 RMS On-state Current vs. Case Temperature**

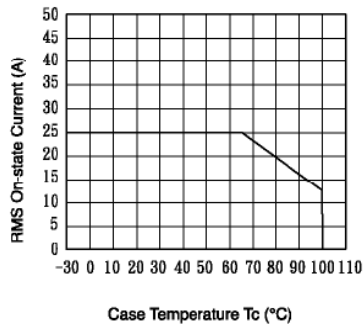

**Fig.5 Input Voltage vs. Ambient Temperature**

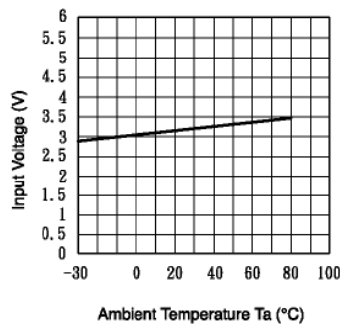

**Fig.6 Input Current vs. Input voltage**

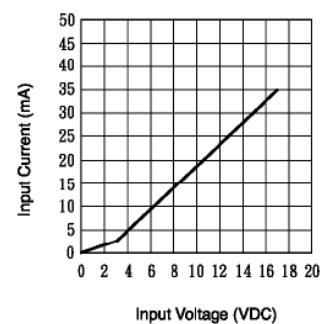

**Fig.7 Action waveform**

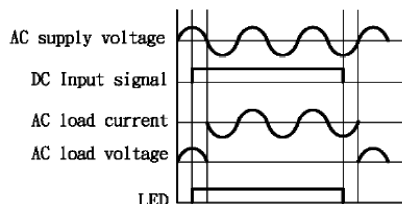

**Fig.8 WIRING DIAGRAM**

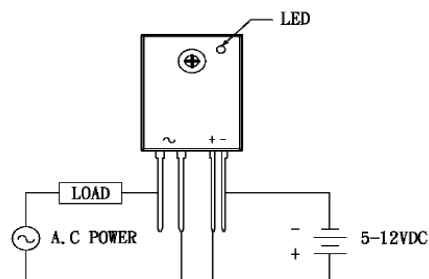

OPTEK reserves the right to make changes at any time in order to improve design and to supply the best product possible.

# Solid State Relays

## 4-Pin SIP Package—VDC Input / VAC Output

### OSSRD1001A thru OSSRD1006A

## OSSRD1006A

### Characteristic Data Curves

**Fig.1 RMS On-state Current vs. Ambient Temperature**

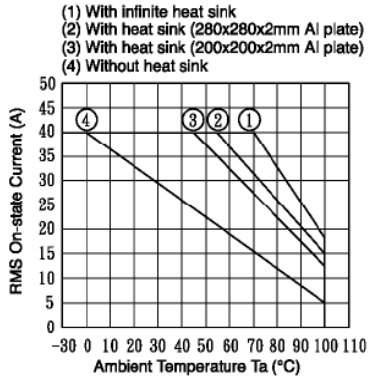

**Fig.2 Surge Current vs. Time**

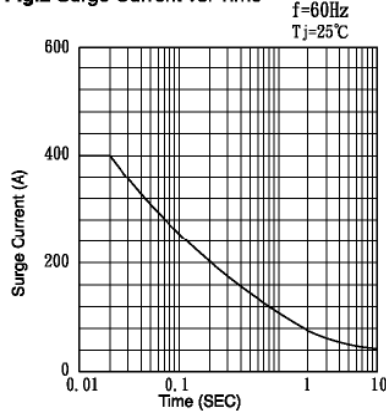

**Fig.3 Open Circuit Leak Current vs. Supply Voltage**

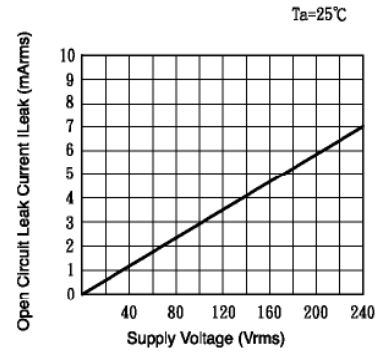

**Fig.4 RMS On-state Current vs. Case Temperature**

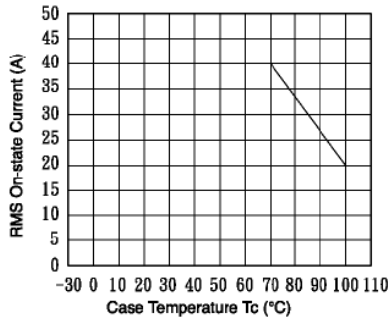

**Fig.5 Input Voltage vs. Ambient Temperature**

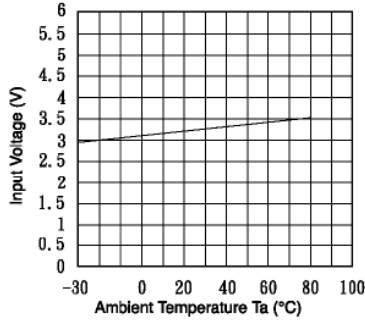

**Fig.6 Input Current vs. Input voltage**

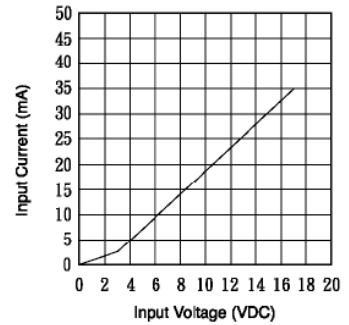

**Fig.7 Action waveform**

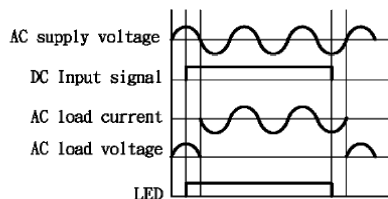

**Fig.8 WIRING DIAGRAM**

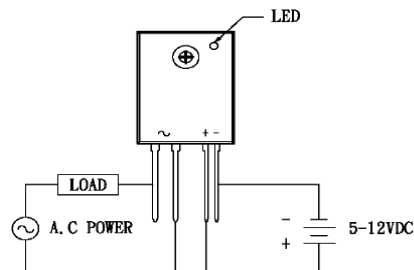

OPTeK reserves the right to make changes at any time in order to improve design and to supply the best product possible.

# Solid State Relays

## 4-Pin SIP Package—VDC Input / VAC Output

### OSSRD1001A thru OSSRD1006A



#### Quality and Reliability Requirements:

Parameter	Failure Criteria	Test Conditions
Room Temperature Operating Life (for light emitting diodes only)	± 20%	T <sub>A</sub> = 25°C, I <sub>F</sub> = 60mA or max. rated, Time = 1000 hours
High Humidity, High Temperature Reverse Bias	± 20%	JEDEC, Method A101-B T <sub>A</sub> = 85°C, Humidity = 85%RH, Time = 1000 hours
High Temperature Forward Bias	± 20%	JEDEC, Method A108-A T <sub>A</sub> = 70°C, I <sub>F</sub> = 20mA, Time = 1000 hours
Autoclave	0 Fail	T <sub>A</sub> = 121°C, Pressure = 15psi, Humidity = 100%
IR Reflow / Solderability Test	0 Fail	JEDEC (J-STD-020) / MIL-STD-883E, Method 2003.7
MTTF @ 90% confidence	150,000 Min.	@ 25°C, 25mADC
Moisture Sensitivity Level	MSL 1	per JDEC stnd J-STD-020B
Glass Transition of body	125°C Min.	DSC test method
Temperature Humidity-Bias	± 20%	85°C, 85%RH, 500Hrs, 80% min I <sub>ceo</sub>
Temperature Cycle	± 20%	per Method 1010.7 of MIL-STD-883E
High Temperature Storage	± 20%	85°C, 500Hrs

#### Label Identification:

#### DESCRIPTION:

Size: 3" (7.4 cm) X 2.2" (5.5 cm)  
 Lettering shall be black on white background.  
 Format shall be as:

#### Notes:

- The DATE CODE is a 4-digit code for date of manufacture where YY is the last two digits of the year, and WW is week number of manufacture.
- The LOT I.D. is the manufacturing location lot identification where Y is the year of manufacture, NNNN is a sequential lot identifier, and DDD is the day of the year of manufacture. – or use equivalent label format.

 Carrollton, TX, USA MADE IN TAIWAN 
OPTEK P/N <u>  OSSRD1001A  </u> 
QTY. <u>      —      </u> 
DATE CODE <u>      (Y Y W W)      </u> 
LOT I.D. <u>      (Y - N N N N D D D)      </u> 

OPTEK reserves the right to make changes at any time in order to improve design and to supply the best product possible.

# Solid State Relays

## 4-Pin SIP Package—VDC Input / VAC Output

### OSSRD1001A thru OSSRD1006A



#### Packaging Information:

Optek's Solid-State Relays Part Numbers (4-Pin SIP)		Packaging Quantities	Tubes		Inner		Medium Carton			Large Carton		
			Qty	Weight (g)	Qty	Weight (kg)	Qty	Net Weight (kg)	Gross Weight (kg)	Qty	Net Weight (kg)	Gross Weight (kg)
		Package Type		53.5 x 7.0 x 7.5 cm		55.5 x 30.7 x 16.5 cm			55.5 x 30.7 x 23.5 cm			
SSR	OSSRD2001D, OSSRD2002A	4 Pin SIP (24mm x 37mm)	10	213	80	1.80	640	14.4	15.4	960	21.6	22.9
	OSSRD1001A - OSSRD1006A	4 Pin SIP (32mm x 24mm)	20	421	80	1.90	640	15.2	16.2	960	22.8	24.1

Optek's Solid-State Relays Part Numbers (Panel Mounts)		Packaging Quantities	Trays		Small Carton			Medium Carton			Large Carton		
			Qty	Weight (g)	Qty	Net Weight (kg)	Gross Weight (kg)	Qty	Net Weight (kg)	Gross Weight (kg)	Qty	Net Weight (kg)	Gross Weight (kg)
		Package Type		36 x 20 x 37 cm		37 x 21 x 11 cm			37 x 21 x 17 cm			37 x 21 x 32 cm	
SSR	OSSRD0001A - OSSRD0006A OSSRA0007A - OSSRA0012A	Panel Mounts (42.5mm x 58mm)	10	920	30	2.80	3.3	50	4.7	5.4	100	9.5	10.5

#### Tube and Carton Packaging Specifications:

##### Tube Packaging Dimensions

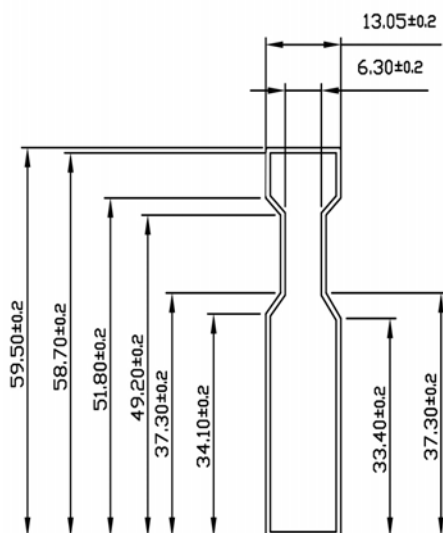

All dimensions are in millimeters

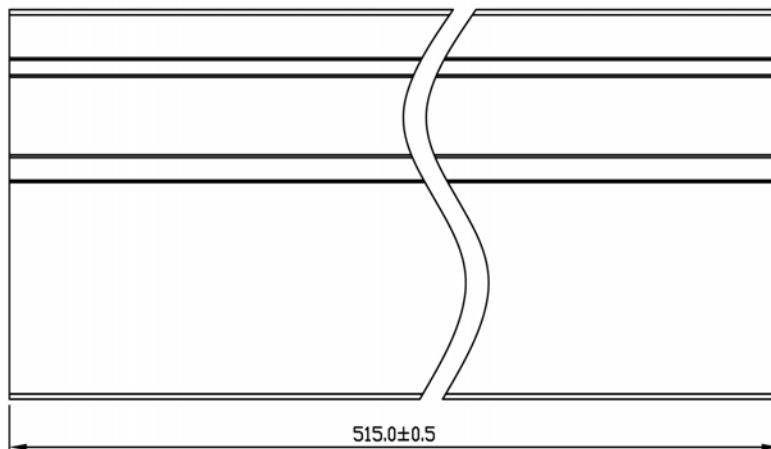

OPTEK reserves the right to make changes at any time in order to improve design and to supply the best product possible.

# Solid State Relays

## 4-Pin SIP Package—VDC Input / VAC Output

### OSSRD1001A thru OSSRD1006A



#### Tray and Carton Packaging Specifications (Cont.):

##### Carton Packaging Dimensions

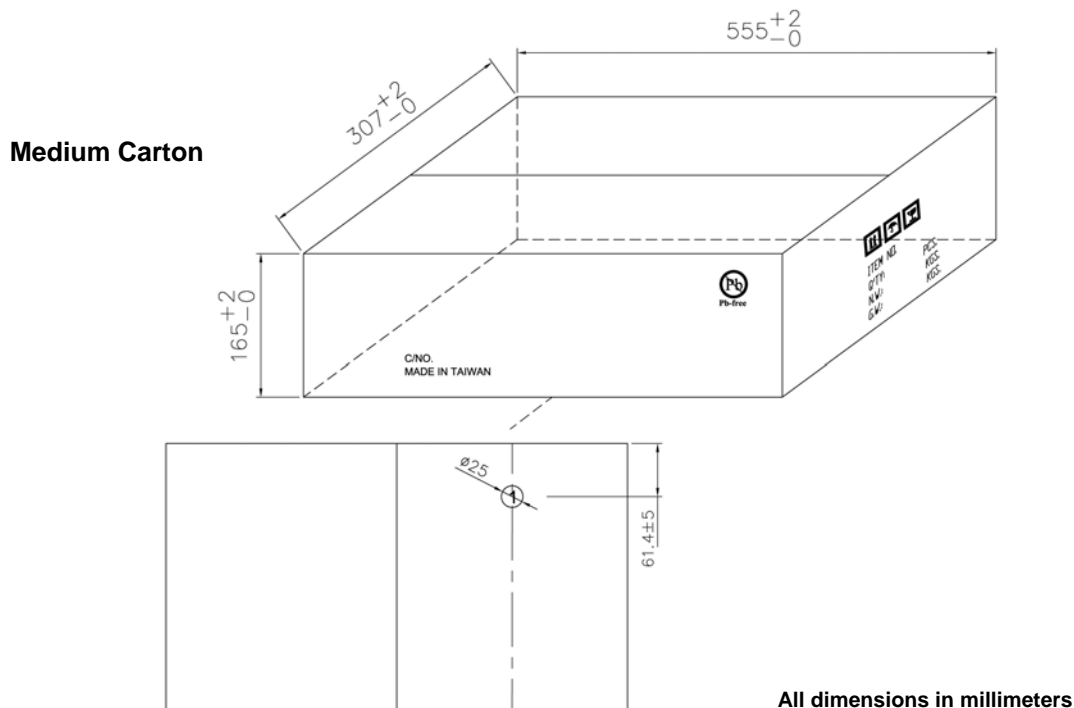
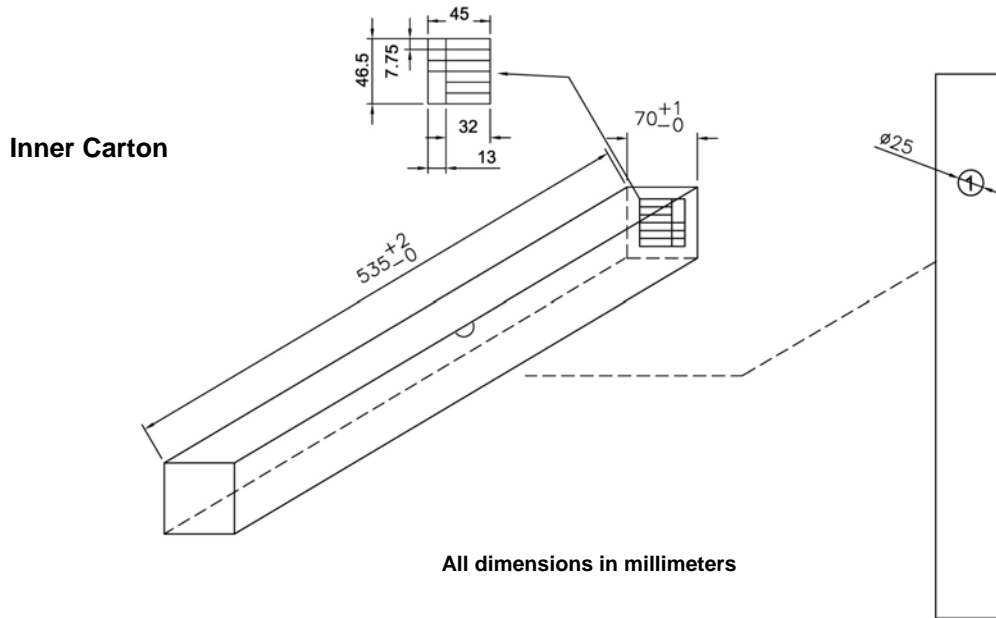

OPTEK reserves the right to make changes at any time in order to improve design and to supply the best product possible.

# Solid State Relays

## 4-Pin SIP Package—VDC Input / VAC Output

### OSSRD1001A thru OSSRD1006A



#### Tray and Carton Packaging Specifications (Cont.):

##### Carton Packaging Dimensions

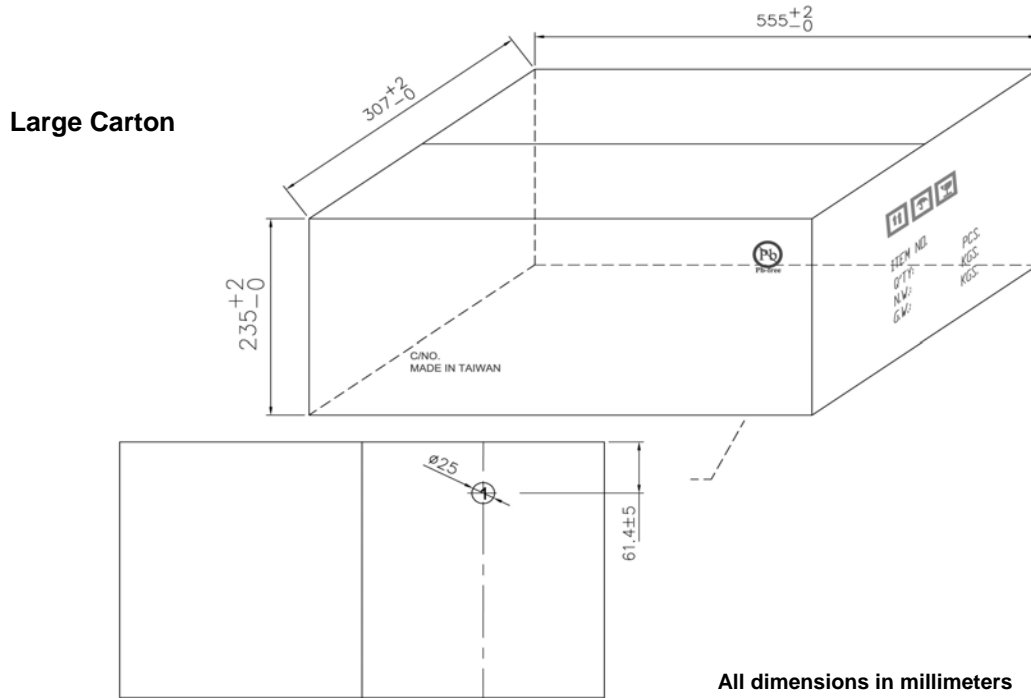

OPTEK reserves the right to make changes at any time in order to improve design and to supply the best product possible.